

**INSTALLATION, OPERATION & PARTS
Owner's Manual**

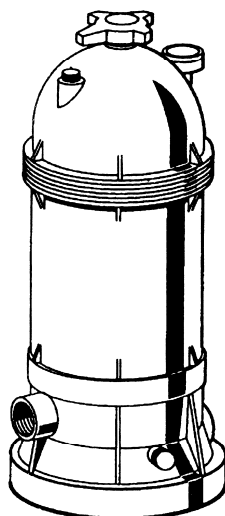



HAYWARD STAR-CLEAR™ PLUS CARTRIDGE FILTERS
Models C751 C7512 C900 C9002(S) C1200 C12002(S) C1502 C17502(S) C2002

MODEL	EFFECTIVE FILTRATION AREA		DESIGN FLOW RATE RESIDENTIAL		DESIGN FLOW RATE PUBLIC	
	FT ²	M ²	GPM	LPM	GPM	LPM
C751	75	7.0	75	284	28	106
C900	90	8.4	90	341	34	129
C1200	120	11.1	120	454	45	170
C7512	75	7.0	75	284	28	106
C9002(S)	90	8.4	90	341	34	129
C12002(S)	120	11.1	120	454	45	170
C1502	150	13.9	120	454	56	212
C17502(S)	175	16.3	120	454	66	250
C2002	200	18.6	120	454	75	284

MAXIMUM WORKING PRESSURE FOR ALL MODELS 50 PSI (3.45 BAR)

ATTENTION INSTALLER: THIS MANUAL CONTAINS IMPORTANT INFORMATION ON THE OPERATION, AND SAFE USE OF THIS EQUIPMENT. THIS MANUAL IS INTENDED FOR THE END USER OF THIS PRODUCT

 This is the safety-alert symbol. When you see this symbol on your equipment or in this manual, look for one of the following signal words and be alert to the potential for personal injury or death.

 **WARNING** Warns about hazards that **could** cause serious personal injury or, death, and or major property damage and if ignored presents a potential hazard.

 **CAUTION** Warns about hazards that **will** or **can** cause minor or moderate personal injury and/or property damage and if ignored presents a potential hazard. It can also make consumers aware of actions that are unpredictable and unsafe. The **NOTICE** label indicates special instructions that are important but not related to hazards.

 **READ, UNDERSTAND, AND FOLLOW ALL SAFETY AND OPERATION INSTRUCTIONS.** FAILURE TO FOLLOW SAFETY AND OPERATION INSTRUCTIONS CAN RESULT IN SEVERE PERSONAL INJURY OR DEATH.



 **CAUTION** To reduce risk of injury, do not permit children to use or climb on this product. Closely supervise children at all times. The ANSI/NSPI-4 Standard (above-ground and on-ground pools) advises that components such as the filtration system, pumps, and heaters be positioned to prevent their being used as a means of access to the pool by young children.



 **WARNING COMPONENT SEPARATION HAZARD**

Pool and spa water circulation systems operate under hazardous pressure during start up, normal operation, and possibly after pump shut off. Pressure in system can cause explosive component separation of the upper filter body if safety and operation instructions are not followed. Severe personal injury or death can result.

 **This product should be installed and serviced only by a qualified pool professional. TO AVOID COMPONENT SEPARATION**

- Follow all safety and operation instructions.
- Do not operate water circulation system if a system component is assembled improperly, damaged, missing, or not a genuine Hayward component.
- Before performing maintenance on the water circulation system, verify all system and pump controls are in OFF position and filter manual air relief valve is in the OPEN position.
- Before starting the system pump, verify that system valves are set in a position to allow water from the filter to return back to the pool.
- Before starting the system pump, the manual air relief valve must be in the OPEN position.
- When starting pump, do not stand over or near filter.
- Return to filter to close manual air relief valve only when a steady stream of water (Not air or air and water mix) is discharged from the manual air relief valve.



 **WARNING EXCESS PRESSURE HAZARD**

Pressure testing of the pump and filter system in excess of the 50 PSI can cause explosive separation of the components. Component separation can result in severe personal injury or death.



 **WARNING ELECTROCUTION HAZARD**

High voltage electricity is present in the pool and spa equipment. High voltage electricity can cause shock and electrocution. Shock and electrocution can result in severe personal injury or death.

- All electrical wiring **MUST** be in conformance with applicable local codes, regulations and the National Electrical Code (NEC).
- Before performing any service or maintenance on electrical equipment turn off all electrical power.
- Contact a licensed electrician or building inspector for information on local electrical codes for bonding requirements.
- Verify water discharge from the filter manual air relief valve is directed away from electrical devices.
- Do not locate pump controls over or near filter.



 **WARNING SUCTION ENTRAPMENT HAZARD.**

Suction in suction outlets and/or suction outlet covers that are, damaged, broken, cracked, missing, or unsecured can cause severe injury and/or death due to the following entrapment hazards:

Hair Entrapment- Hair can become entangled in suction outlet cover.

Limb Entrapment- A limb inserted into an opening of a suction outlet sump or suction outlet cover that is damaged, broken, cracked, missing, or not securely attached can result in a mechanical bind or swelling of the limb.

Body Suction Entrapment- A negative pressure applied to a large portion of the body or limbs can result in an entrapment.

Evisceration/ Disembowelment Entrapment- A negative pressure applied directly to the intestines through an unprotected suction outlet sump or suction outlet cover that is, damaged, broken, cracked, missing, or unsecured can result in evisceration/ disembowelment entrapment.

Medical Entrapment- There is potential for jewelry, swimsuit, hair decorations, finger, toe or knuckle to be caught in an opening of a suction outlet cover resulting in mechanical entrapment.



USE ONLY HAYWARD GENUINE REPLACEMENT PARTS

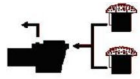

TO REDUCE THE RISK OF ENTRAPMENT HAZARDS:

- A minimum of two functioning suction outlets per pump must be installed. Suction outlets in the same plane (i.e. floor or wall), must be installed a minimum of three feet (3') [1 meter] apart, as measured from near point to near point.
- Dual suction outlets shall be placed in such locations and distances to avoid "dual blockage" by a user.
- Dual suction outlets shall not be located on seating areas or on the backrest for such seating areas.
- The pool or spa circulation system shall be designed to comply with ANSI/APSP-7 2006.
- Suction outlet covers shall conform to ANSI/ASME A112.19.8
- Never use Pool or Spa if any suction outlet component (cover/grate) is damaged, broken, cracked, missing, or not securely attached.
- Immediately replace damaged, broken, cracked, missing, or not securely attached suction outlet components.
- The CPSP as well as the ICC *International Residential Code* Part IX, Appendix G, Section AG106 specifies the installation of a safety vacuum release system conforming to ASME A112.19.17, or an approved gravity drain system.
- Failure to remove pressure test plugs and/or plugs used in winterization of the pool/spa from the suction outlets can result in an increased potential for suction entrapment.
- Failure to keep suction outlet components clear of debris, such as leaves, dirt, hair, paper and other material can result in an increased potential for suction entrapment.

Suction outlet covers and grates have a finite life. They should be inspected frequently and replaced within specified life.

GENERAL INFORMATION

The Hayward Star-Clear Plus filter is a high performance swimming pool filter with a residential filtration rating of 4,500 gallons (17 kl) per hour (C751), 5,400 gallons (20.5 kl) per hour (C900), or 7,200 gallons (27.3 kl) per hour (C1200, C1502, C1750, and C2002). Manufactured from durable, corrosion-proof materials, they are designed for continuous or intermittent operation, for installation above or below the pool water line, for fresh or saltwater swimming pools or spas. Star-Clear Plus filters utilize a reusable single element, reinforced polyester filter cartridge to provide a high degree of water clarity with absolute minimum care. Their unique design is such that no tools are needed to remove or replace the cartridge in the filter assembly. Simply spin off the locking knob, lift off the filter cover and remove the cartridge. It's that easy.

PUMP SELECTION AND LOCATION

To power your Star-Clear Plus filter, select a continuous duty pump designed for swimming pool or spa service. It is important to first determine where your pump and filter will be located. If above the water line, a self-priming pump must be used. Self-priming pumps such as Hayward's Super Pump®, Super II™, or TriStar™ have the ability to lift water from a lower level and prime automatically.

Select a pump appropriate for your application. Taking into consideration, operation of hydrotherapy fittings, automatic cleaners, required turn over rates and losses in the system. A dealer can help you select the proper size pump for your system.

FILTER LOCATION

1. Since plumbing fittings offer a resistance to water flow, position the filter as close to the swimming pool as local codes allow. Keep the number of fittings to a minimum. Select a well drained area, one that will not flood when it rains.
2. Set the filter on a solid level surface. Allow a minimum top clearance for cartridge removal of 19" (483mm) for the C751 and C900, 25" (635mm) for the C1200, C1502 and allow 30" (762mm) for the C1750 and C2002. Be sure filter, pump, drain & pressure gauge are accessible for convenient operation.
3. Position the filter so the tank can drain by gravity.
4. If practical, place pump and filter in the shade to shield it from continuous, direct heat from the sun.

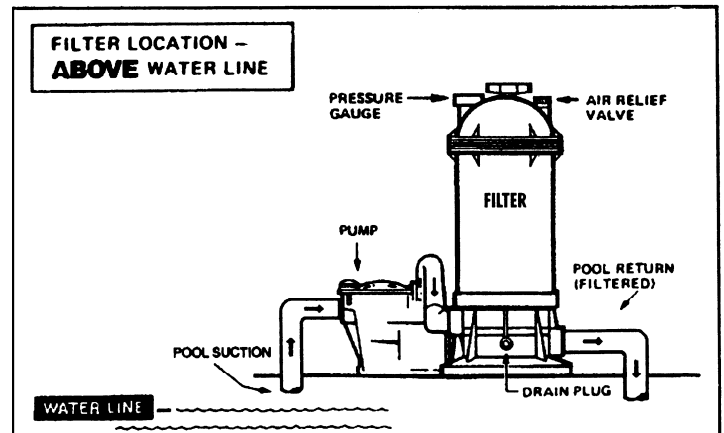
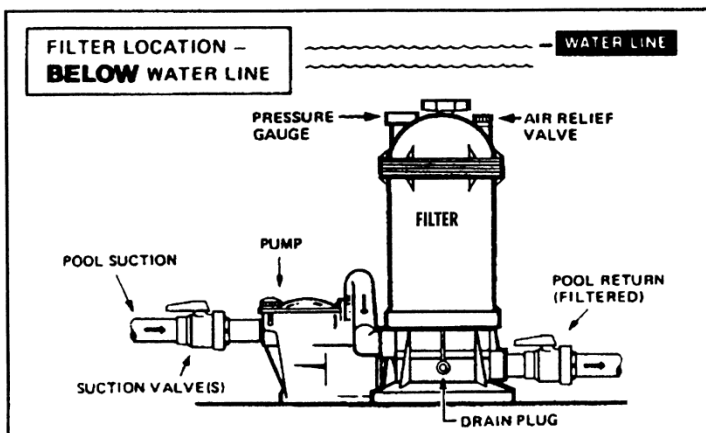

USE ONLY HAYWARD GENUINE REPLACEMENT PARTS

PLUMBING

1. Use 1-1/2" or 2" piping. When making permanent connections, be sure to provide unions for easy servicing.
2. Refer to the diagrams on previous page for basic suggested valving. Ball valves are recommended where needed. While systems vary, the main consideration is to provide the desired control of water flow from the pool to the pump and filter, and back to the pool. When the filter is located below water level, provide valves to prevent back flow of water to the filter during cleaning and routine servicing.
3. All plumbing on the Star-Clear Plus filter is 1-1/2" or 2" N.P.T. or socket (solvent weld). When making threaded connections to the filter use plastic adapters. Apply three turns of Teflon tape (or use special plastic pipe sealant) to male threads. Screw the fitting into the thread hand tight; then using a wrench, tighten one more full turn. Additional tightening is unnecessary and could result in broken or damaged fittings.
4. Connect the pool suction plumbing between the skimmer, pool outlet, etc. and the pump.
5. Install the pool return plumbing.
6. If the pressure gauge is not installed, apply three wraps of Teflon tape to the gauge threads, and *carefully* screw the gauge into the threaded hole in the filter head.
7. A filter drain plug is furnished with each filter and is all that is needed for complete filter draining. A manual air relief valve is furnished to aid in bleeding off unwanted air when starting the filter. The auto air relief provides air removal during operation.
8. All electrical connections should be made in accordance with local codes.
9. Check for joint leaks before operating
10. Refer to pump instruction booklet for pump information.

	REQUIRED CLEARANCE			
	SIDE		ABOVE	
	IN	CM	IN	CM
C751	18	46	19	48
C900	18	46	19	48
C1200	18	46	25	64
C7512	18	46	19	48
C9002(S)	18	46	19	48
C12002(S)	18	46	25	64
C1502	18	46	25	64
C17502(S)	18	46	30	76
C2002	18	46	30	76

STARTING THE FILTER

Be sure filter drain plug is closed. Open manual air relief valve a few turns and open the suction and return valves (when used).

⚠ CAUTION: All suction and discharge valves must be open when starting the system. Failure to do so could cause severe personal injury and/or property damage. Be sure locking knob is secure (hand tighten-only slight pressure is required).

Stand clear of the filter and prime and start the pump, following the manufacturer's instructions. Air trapped in the system will automatically vent to the pool and out air relief valve. Close air relief valve as soon as air is vented.

FILTERING

Filtration starts as soon as flow is steady through the filter. As the filter cartridge removes dirt from the pool water, the accumulated dirt causes a resistance to flow. As a result, the gauge pressure will rise and the flow will decrease. When the pressure rises 7-10 psi (.49-.70 Bar) above the starting pressure, or when flow decreases below desired rate, clean or replace the filter cartridge.

CLEAN / REPLACE CARTRIDGE

REMOVING CARTRIDGE ELEMENT

1. Shut off the pump.
2. If filter is located below water level, close valves or block off suction & discharge lines to prevent backflow of water from the pool.
3. Remove drain plug and allow water to drain from filter. Close drain plug. (To assist draining process; open air vent a few turns.)
4. Unscrew and remove locking knob (counterclockwise direction) and carefully lift off top cover to gain access to filter cartridge.
5. Lift out cartridge and clean. Or, replace with clean, spare cartridge. (See Cleaning Cartridge.)

REINSTALLING CARTRIDGE ELEMENT

1. Clean any collected debris from the bottom of filter body.
2. Carefully replace cartridge element over tie rod and into filter body ensuring that the cartridge sits evenly on the collector hub in bottom of filter body.
3. Place cover on filter body (being sure filter head O-ring is in place and clean). Fit tie rod end through center hole.
4. Tighten locking knob in clockwise direction. (Hand tight only.)
5. Proceed as in **STARTING THE FILTER**.

USE ONLY HAYWARD GENUINE REPLACEMENT PARTS

CLEANING CARTRIDGE

The cartridge filter element can be cleaned by pressure washing inside and out with a garden hose. (The cartridge is easier to clean when dry.) After hosing the cartridge, for best results, allow cartridge to dry and carefully brush pleated surface areas to remove fine particles. **Do not pressure wash, as it can damage the filter element.**

Algae, suntan oil and body oils can form a coating on the cartridge pleats which may not be thoroughly removed by hosing. To remove such materials, soak the cartridge in a solution of filter element cleaner (various brands available at pool dealer). Follow manufacturer's directions for use and allow an hour for soaking. Hose thoroughly before reinstalling in filter.

A spare cartridge filter element is an excellent investment. It provides convenience and ensures that your filter will always be ready to operate at peak efficiency.

- Hayward cartridges are specially designed and engineered for use in Star-Clear Plus filters. **For best results, use only genuine Hayward Star-Clear cartridges in your filter.** Order *Model No. CX760RE, CX900RE, CX1200RE, CX1520RE, CX1750RE, or CX2020RE* from your dealer. The Hayward name is your guarantee of quality.

VACUUMING

Vacuuming can be performed directly into the filter whenever needed. Clean cartridge after vacuuming, if required.

WINTERIZING (Filter)

In areas where sub-freezing temperatures can be expected, the filter should be drained and/or removed from its, operating location and stored indoors. Remove and clean cartridge. Reinstall cartridge in filter tank. Tighten locking knob only a few turns when storing.

SERVICE AND REPAIRS

Consult your local authorized Hayward dealer or service center. No returns may be made directly to the factory without the expressed written authorization of Hayward Pool Products.

SUGGESTED POOL CHEMISTRY LEVELS	
pH	7.2 to 7.8
TOTAL ALKALINITY	80 to 120 ppm
CALCIUM HARDNESS	200 to 400 ppm
COMBINED CHLORINE	.2 ppm Maximum
CHLORINE (STABILIZED)	1.0 to 3.0 ppm
CHLORINE STABILIZER (Cyanuric Acid)	60 to 80 ppm

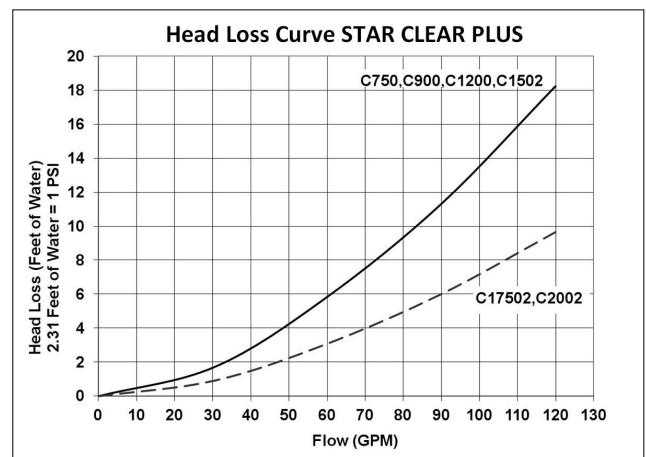

USE ONLY HAYWARD GENUINE REPLACEMENT PARTS

PROBLEM SOLVING LIST

REMEDY	LOW WATER FLOW	SHORT FILTER CYCLES	POOL WATER WON'T CLEAR UP
	<ol style="list-style-type: none"> 1. Check skimmer and pump strainer baskets for debris. 2. Check for restrictions in intake and discharge lines. 3. Check for air leak in intake line (indicated by bubbles returning to pool). 4. Clean Filter Cartridges (see Page 5) 	<ol style="list-style-type: none"> 1. Check for algae in pool and treat as required. 2. Be sure chlorine and pH levels are in proper range (adjust as required). 	<ol style="list-style-type: none"> 1. Check chlorine, pH and total alkalinity levels and adjust as required. 2. Be sure flow rate through filter is sufficient. 3. Operate filter for longer periods.

PARTS
 Models C751, C7512, C900, C9002(S), C1200, C12002(S) C1502, C17502(S), and C2002 Filters

REF NO.	PART NO.	DESCRIPTION	NO. REQ'D.
1a	CX900G	Locking Knob	1
1b	CX1750G	Locking Knob	1
2	CX900H	O-Ring	1
3	CX900W	Washer	2
4	CX900J	E-Ring	1
5	CX900D	Guide Cone	1
6a	CX900B	Filter Head w/Directional Vent	1
6b	CX1200B	Filter Head w/Directional Vent	1
6c	CX1750B	Filter Head w/Directional Vent	1
7	CX900F	Filter Head O-Ring	1
8a	CX900AA	Filter Body-1-1/2" FIP	1
8b	CX900AA2	Filter Body-2" FIP	1
9	ECX2712B1	Pressure Gauge	1
10a	CX760RE	Cartridge Element (C751, C7512)	1
10b	CX900RE	Cartridge Element (C900)	1
10c	CX1200RE	Cartridge Element (C1200)	1
10d	CX1750RE	Cartridge Element (C1750)	1
10e	CX1520RE	Cartridge Element (C1502)	1
10f	CX2020RE	Cartridge Element (C2002)	1
11a	CX800Z2	Tie Rod (C900)	1
11b	CX1100Z2	Tie Rod (C1200)	1
11c	CX1750Z2	Tie Rod (C1750)	1
12a	CX800Z4	Auto Air Relief Tube (C900)	1
12b	CX1100Z4	Auto Air Relief Tube (C1200)	1
12c	CX1750Z4	Auto Air Relief Tube (C1750)	1
13	CX250Z14A	1/2" Drain Plug with O-Ring	1
14	CX900K	2" PVC Socket Connector Set of 2 (Not Shown)	2
15	ECX1322A	Directional Vent Valve w/O-Ring	1

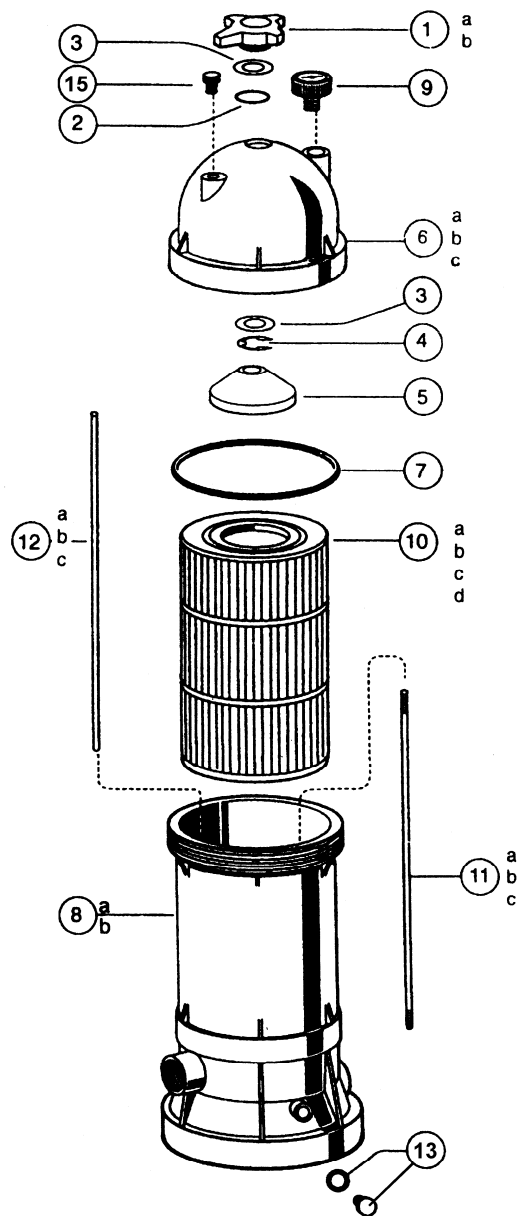

USE ONLY HAYWARD GENUINE REPLACEMENT PARTS